



SPLIT-TYPE, AIR CONDITIONERS
SPLIT-TYPE, HEAT PUMP AIR CONDITIONERS

Changes for the Better

Revision B:

- MXZ-2A20NA-1, MXZ-4A36NA, MSZ-FD, MSZ-D and MSY-D have been added.

Please void OBT16 REVISED EDITION-A.

**No. OBT16
REVISED EDITION-B**

SERVICE TECHNICAL GUIDE

Wireless type Models

**MS-A•WA
MSZ-A•NA**

**MSY-A•NA
MSZ-FD•NA**

MSZ-D•NA

MSY-D•NA

- **MU-A•WA**
- **MUZ-A•NA**
- **MUZ-A•NA** - U
- **MUY-A•NA**
- **MUZ-FD•NA**
- **MUZ-FD•NA** - U
- **MUZ-D•NA**
- **MUZ-D•NA** - U
- **MUY-D•NA**

Inverter-controlled multi system type Models

- **MXZ-A•NA**

CONTENTS

1. MS MICROPROCESSOR CONTROL.....	4
2. MSZ, MSY MICROPROCESSOR CONTROL.....	7
3. MXZ MICROPROCESSOR CONTROL.....	21

Revision A:

- MXZ-3A30NA- has been added.

Revision B:

- MXZ-2A20NA-, MXZ-4A36NA, MSZ-FD, MSZ-D and MSY-D have been added.

1. MS MICROPROCESSOR CONTROL	4		
Indoor unit models	Outdoor unit models		
MS-A09WA	MU-A09WA		
MS-A12WA	MU-A12WA		
1-1. COOL OPERATION	4		
1-2. DRY OPERATION	4		
1-3. AUTO VANE OPERATION.....	6		
2. MSZ, MSY MICROPROCESSOR CONTROL	7		
Indoor unit models	Outdoor unit models		
MSZ-A09NA	MSZ-FD09NA	MUZ-A09NA	MUZ-FD09NA
MSZ-A12NA	MSZ-FD12NA	MUZ-A12NA	MUZ-FD12NA
MSZ-A15NA	MSZ-D30NA	MUZ-A15NA	MUZ-D30NA
MSZ-A17NA	MSZ-D36NA	MUZ-A17NA	MUZ-D36NA
MSZ-A24NA	MSY-D30NA	MUZ-A24NA	MUY-D30NA
MSY-A15NA	MSY-D36NA	MUY-A15NA	MUY-D36NA
MSY-A17NA		MUY-A17NA	
MSY-A24NA		MUY-A24NA	
2-1. COOL OPERATION	7		
2-2. DRY OPERATION	8		
2-3. HEAT OPERATION	8		
2-4. AUTO CHANGE OVER ... AUTO MODE OPERATION	10		
2-5. OUTDOOR FAN MOTOR CONTROL.....	11		
2-6. AUTO VANE OPERATION.....	11		
2-7. INVERTER SYSTEM CONTROL.....	12		
2-8. OPERATIONAL FREQUENCY CONTROL OF OUTDOOR UNIT	17		
2-9. EXPANSION VALVE CONTROL (LEV CONTROL).....	18		
3. MXZ MICROPROCESSOR CONTROL	21		
Outdoor unit models			
MXZ-2A20NA			
MXZ-3A30NA			
MXZ-4A36NA			
3-1. INVERTER SYSTEM CONTROL	21		
3-2. EXPANSION VALVE CONTROL (LEV CONTROL)	23		
3-3. OPERATIONAL FREQUENCY RANGE	29		
3-4. HEAT DEFROSTING CONTROL.....	30		
3-5. DISCHARGE TEMPERATURE PROTECTION CONTROL.....	30		
3-6. OUTDOOR FAN CONTROL	30		
3-7. PRE-HEAT CONTROL	31		
3-8. COOL OPERATION.....	31		
3-9. DRY OPERATION.....	BACK COVER		
3-10. HEAT OPERATION	BACK COVER		

MS-A•WA MU-A•WA

1-1. COOL (❄) OPERATION

1. Thermostat control

Thermostat is ON or OFF by difference between room temperature and set temperature

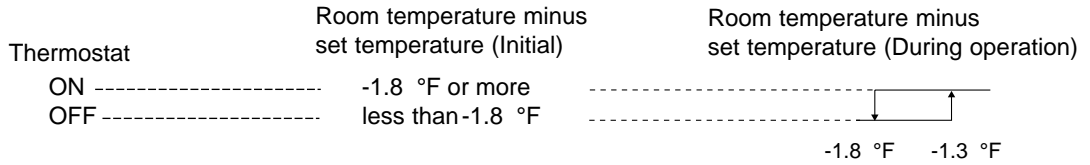

2. Indoor fan speed control

Indoor fan operates continuously at the set speed by FAN SPEED CONTROL button regardless of the thermostat's OFF-ON.

In AUTO the fan speed is as follows.

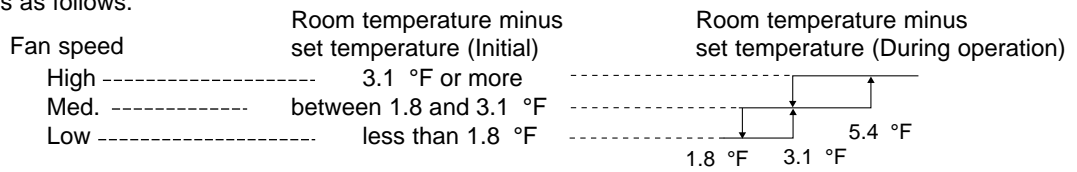

3. Coil frost prevention

① Temperature control

When the indoor coil thermistor RT12 reads 37 °F or below the coil frost prevention mode starts immediately.

However, the coil frost prevention doesn't work for 5 minutes since the compressor has started.

The indoor fan operates at the set speed and the compressor stops for 5 minutes.

After that, if the indoor coil thermistor still reads below 37 °F, this mode is prolonged until the indoor coil thermistor reads over 37 °F.

② Time control

When the three conditions as follows have been satisfied for 1 hour and 45 minutes, compressor stops for 3 minutes.

- a. Compressor has been continuously operating.
- b. Indoor fan speed is Low or Med.
- c. Room temperature is below 79 °F.

When compressor stops, the accumulated time is cancelled and when compressor restarts, time counting starts from the beginning.

Time counting also stops temporarily when the indoor fan speed becomes High or the room temperature exceeds 79 °F. However, when two of the above conditions (b. and c.) are satisfied again. Time accumulation is resumed.

Operation chart

Example

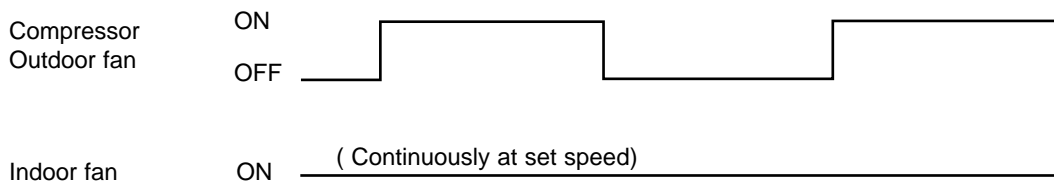

1-2. DRY (△) OPERATION

Set temperature is as shown on the right chart.

The system for dry operation uses the same refrigerant circuit as the cooling circuit.

The compressor and the indoor fan are controlled by the room temperature.

By such controls, indoor flow amounts will be reduced in order to lower humidity without much room temperature decrease.

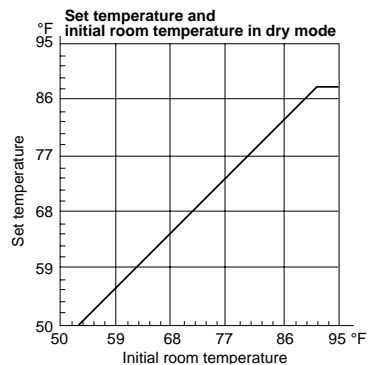

1. Thermostat control

Thermostat is ON or OFF by difference between room temperature and set temperature.

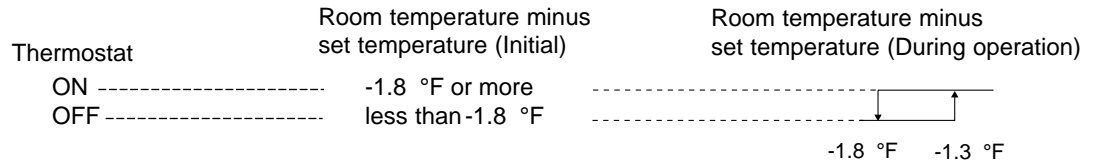

2. Indoor fan speed control

Indoor fan operates at the set speed by FAN SPEED CONTROL button. When thermostat OFF (compressor OFF), fan speed becomes Very Low. In AUTO the fan speed is as follows.

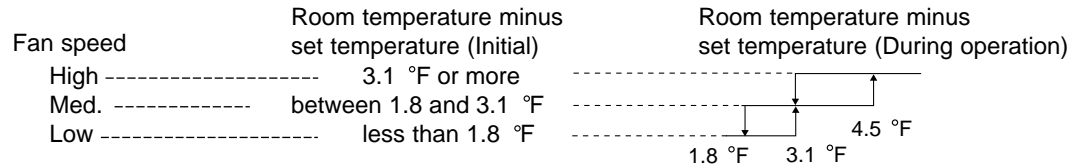

3. The operation of the compressor and indoor/ outdoor fan

Compressor operates by room temperature control and time control. Set temperature is controlled to fall 4 °F from initial room temperature. Indoor fan and outdoor fan operate in the same cycle as the compressor.

- When the room temperature is 73 °F or over:
 - When the thermostat is ON, the compressor repeats 8 minutes ON and 3 minutes OFF.
 - When the thermostat is OFF, the compressor repeats 4 minutes OFF and 1 minute ON.
- When the room temperature is under 73 °F.
 - When the thermostat is ON, the compressor repeats 2 minutes ON and 3 minutes OFF.
 - When the thermostat is OFF, the compressor repeats 4 minutes OFF and 1 minute ON.

Operation time chart

Example

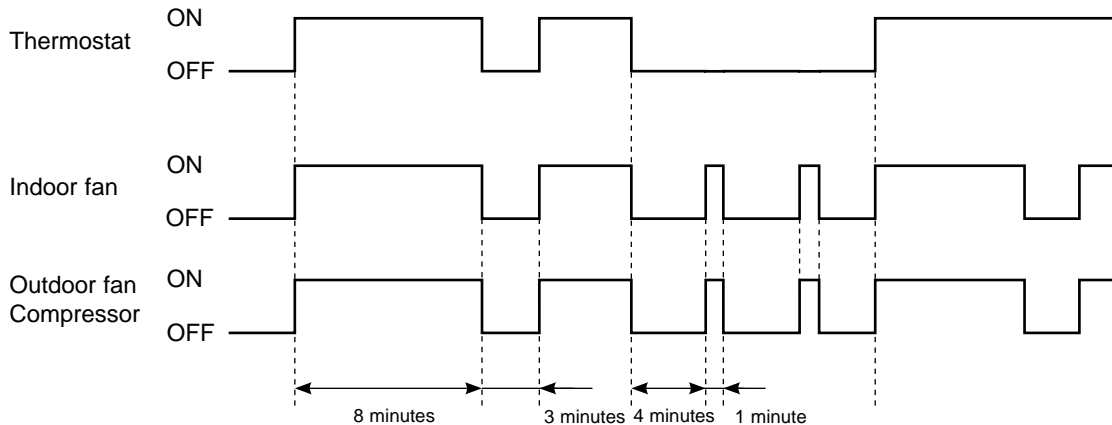

4. Coil frost prevention

Coil frost prevention is as same as COOL mode. (2-1.3.)

The indoor fan maintains the actual speed of the moment. However, when coil frost prevention works while the compressor is not operating, its speed becomes the set speed.

1-3. AUTO VANE OPERATION

1. Horizontal vane

ECONO COOL () operation (ECONOMical operation)

When ECONO COOL button is pressed in COOL mode, set temperature is automatically set 3.6 °F higher than that in COOL mode.

Also the horizontal vane swings in various cycle according to the temperature of indoor heat exchanger (indoor coil thermistor).

SWING operation makes you feel cooler than set temperature. So, even though the set temperature is higher than that in COOL mode, the air conditioner can keep comfort. As a result, energy can be saved.

ECONO COOL operation is cancelled when ECONO COOL button is pressed once again or VANE CONTROL button is pressed or change to other operation mode.

<SWING operation>

In swing operation of ECONO COOL operation mode, the initial air flow direction is adjusted to "Horizontal".

According to the temperature of indoor coil thermistor at starting of this operation, next downward blow time is decided.

Then when the downward blow has been finished, next horizontal blow time is decided.

For initial 10 minutes the swing operation is performed in table G~H for quick cooling.

Also, after 10 minutes when the difference of set temperature and room temperature is more than 3.6 °F, the swing operation is performed in table D~H for more cooling.

The air conditioner repeats the swing operation in various cycle as follows.

	Temperature of indoor coil thermistor (°F)	Downward blow time (second)	Horizontal blow time (second)
A	59 or less	2	23
B	59 to 63	5	20
C	63 to 64	8	17
D	64 to 68	11	14
E	68 to 70	14	11
F	70 to 72	17	8
G	72 to 75	20	5
H	more than 75	23	2

MSZ-A•NA MSY-A•NA MUZ-A•NA MUY-A•NA
 MSZ-FD•NA MSY-D•NA MUZ-FD•NA MUY-D•NA
 MSZ-D•NA MUZ-D•NA

2-1. COOL (❄) OPERATION

1. Thermostat control

Thermostat is ON or OFF by difference between room temperature and set temperature

Thermostat	Room temperature minus set temperature (Initial)	Room temperature minus set temperature (During operation)
ON -----	-1.8 °F or more	
OFF -----	less than -1.8 °F	

2. Indoor fan speed control

Indoor fan operates continuously at the set speed by FAN SPEED CONTROL button regardless of the thermostat's OFF-ON.

In AUTO the fan speed is as follows.

Model	Fan speed	Room temperature minus set temperature (Initial)	Room temperature minus set temperature (During operation)
MSZ-A MSY-A	High -----	3.1 °F or more	
	Med. -----	between 1.8 and 3.1 °F	
	Low -----	less than 1.8 °F	
MSZ-FD MSZ-D MSY-D	High -----	2.7 °F or more	
	Med. -----	between 1.8 and 2.7 °F	
	Low -----	less than 1.8 °F	

3. Coil frost prevention

The compressor operational frequency is controlled to prevent the temperature of indoor heat exchanger from falling excessively.

The compressor is turned OFF for 5 minutes when the temperature of indoor coil thermistor continues 37 °F or less for 5 minutes or more.

The indoor fan maintains the actual speed of the moment.

4. Low outside temperature operation

If the outside temperature falls to 64 °F or less during operation in COOL mode, the unit will switch to the low outside temperature operation mode.

<Operation>

(1) Outdoor fan control

The outdoor fan rotation speed slows down to maintain sufficient cooling capacity.

NOTE: Even when the unit is in the "thermostat-off" status under the low outside temperature operation mode, the outdoor fan rotation does not stop.

(2) Dew drop prevention

When the ambient temperature thermistor reads 10 °F (**MUZ-A MUY-A MUZ-D MUY-D**), -4 °F (**MUZ-FD**) or less, as coil frost or dew drop from indoor unit may occur, the compressor turns OFF with the outdoor fan ON for prevention of them.

(3) Outdoor temperature detecting control

To detect the exact outdoor temperature in this mode, the compressor turns OFF but the outdoor fan stays ON for 3 minutes once 1 hour. If the outdoor temperature rises over 64 °F, the unit goes back to the normal COOL mode. If the outside temperature stays below 64 °F, the unit continues to run in the low outside temperature operation mode.

*Other protections work as well as in the normal COOL mode.

2-2. DRY (△) OPERATION

Set temperature is as shown on the right chart.
 The system for dry operation uses the same refrigerant circuit as the cooling circuit.
 The compressor and the indoor fan are controlled by the room temperature.
 By such controls, indoor flow amounts will be reduced in order to lower humidity without much room temperature decrease.

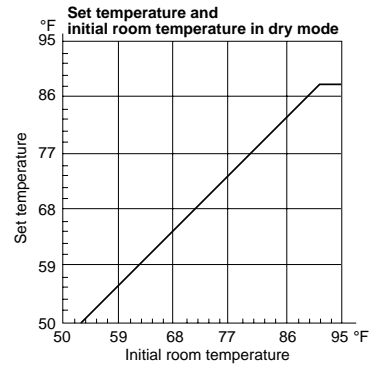

1. Thermostat control

Thermostat is ON or OFF by difference between room temperature and set temperature.

Thermostat	Room temperature minus set temperature (Initial)	Room temperature minus set temperature (During operation)
ON -----	-1.8 °F or more	
OFF -----	less than -1.8 °F	

2. Indoor fan speed control

Indoor fan operates at the set speed by FAN SPEED CONTROL button.
 When thermostat OFF (compressor OFF), fan speed becomes Very Low.
 In AUTO the fan speed is as follows.

Fan speed	Room temperature minus set temperature (Initial)	Room temperature minus set temperature (During operation)
High -----	3.1 °F or more	
Med. -----	between 1.8 and 3.1 °F	
Low -----	less than 1.8 °F	

3. Coil frost prevention

Coil frost prevention is as same as COOL mode. (2-1.3.)

The indoor fan maintains the actual speed of the moment. However, when coil frost prevention works while the compressor is not operating, its speed becomes the set speed.

4. Low outside temperature operation

Low outside temperature operation is as same as COOL mode. (2-1.4.)

2-3. HEAT (⊙) OPERATION (MSZ)

1. Thermostat control

Thermostat is ON or OFF by difference between room temperature and set temperature.

Thermostat	Room temperature minus set temperature (Initial)	Room temperature minus set temperature (During operation)
ON -----	less than 3.6 °F	
OFF -----	3.6 °F or more	

2. Indoor fan speed control

(1) Indoor fan operates at the set speed by FAN SPEED CONTROL button.
 In Auto the fan speed is as follows.

Fan speed	Room temperature minus set temperature (Initial)	Room temperature minus set temperature (During operation)
High -----	3.6 °F or more	
Med. -----	between 0.4 and 3.6 °F	
Low -----	less than 0.4 °F	

(2) Cold air prevention control

MSZ-A09/12/15/17 MSZ-FD MSZ-D

① When the compressor is not operating,

- (I) if the temperature of room temperature thermistor is less than 66 °F, the fan stops.
- (II) if the temperature of room temperature thermistor is 66 °F or more and
 - (i) if the temperature of indoor coil thermistor is less than 32 °F, the fan stops.
 - (ii) if the temperature of indoor coil thermistor is 32 °F or more, the fan operates at Very Low.

② When the compressor is operating,

- (I) if the temperature of indoor coil thermistor is 104 °F or more, the fan operates at set speed.
- (II) if the temperature of indoor coil thermistor is less than 104 °F and
 - (i) if heating operation starts after defrosting, the fan stops.
 - (ii) if the temperature of room temperature thermistor is 66 °F or less, the fan stops.
 - (iii) if the temperature of room temperature thermistor is more than 66 °F, the fan operates at Very Low.

NOTE : When 3 minutes have passed since the compressor started operation, this control is released regardless of the temperature of room temperature thermistor and indoor coil thermistor.

MSZ-A24

① When the compressor is not operating,

- (I) if the temperature of room temperature thermistor is 59 °F or less, or temperature of indoor coil thermistor is less than 64 °F, the fan stops.
- (II) if the temperature of room temperature thermistor is more than 59 °F, or temperature of indoor coil thermistor is more than 64 °F, the fan operates at Very Low.

② When the compressor is operating,

- (I) if the temperature of indoor coil thermistor is 64 °F or more, the fan operates at set speed.
- (II) if the temperature of indoor coil thermistor is less than 64 °F and
 - (i) if heating operation starts after defrosting, the fan stops.
 - (ii) if the temperature of room temperature thermistor is 59 °F or less, the fan stops.
 - (iii) if the temperature of room temperature thermistor is more than 59 °F, the fan operates at Very Low.

NOTE : When 3 minutes have passed since the compressor started operation, this control is released regardless of the temperature of room temperature thermistor and indoor coil thermistor.

(3) Warm air control (**MSZ-FD**)

When the following any condition of ① (a. ~ c.) and the condition of ② are satisfied at the same time, warm air control works.

① a.) Fan speed is used in MANUAL.

b.) When cold air prevention has been released.

c.) When defrosting has been finished.

② When the temperature of indoor coil thermistor is less than 104 °F.

When warm air control works, the fan speed changes as follows to blow out warm air gradually.

Gradation of fan speed in initial

<Time condition>	<Indoor fan speed>
Less than 2 minutes-----	Low
2 minutes to 4 minutes -----	Med.
More than 4 minutes -----	High or Super high

The upper limit of the fan speed in MANUAL is the set speed.

When the temperature of indoor coil thermistor has been 104 °F or more, or when the set speed has been changed, this control is released and the fan speed is the set speed.

3. Overload starting

When the room temperature thermistor reads 64 °F or more, the compressor runs with its maximum frequency regulated for 10 minutes after the start-up.

4. Defrosting

(1) Starting conditions of defrosting

When the following conditions a) ~ c) are satisfied, the defrosting starts.

a) The defrost thermistor reads 27 °F or less.

b) The cumulative operation time of the compressor has reached any of the set values* (40, 45, 55, 65, 75, 85, 95, 105, 115, 125, 150 minutes).

c) More than 5 minutes have passed since the start-up of the compressor.

* Set value of compressor operation time (here in after referred to as defrost interval)

This is decided by the temperature of defrost thermistor, ambient temperature thermistor, and the previous defrosting time. For example, the first defrost interval is 40 minutes long, and the second is 45 minutes long. The third and subsequent intervals are set to be longer, and less frequent, depending on defrosting time.

The third and subsequent defrost intervals follow any of the three patterns ...5 or 10 to 20 minutes longer, the same, or 5 or 10 to 20 minutes shorter compared with the previous defrost interval ... with the longest 125 minutes and the shortest 40 minutes.

(2) Releasing conditions of defrosting

Defrosting is released when any of the following conditions is satisfied:

- a) The defrost thermistor continues to read 50 °F or more (**MUZ-A09/12 MUZ-D**) / 41 °F or more (**MUZ-A15/17 MUZ-FD**) / 59 °F or more (**MUZ-A24**) for 30 seconds.
- b) Defrosting time has exceeded 10 minutes.
- c) Any other mode than HEAT mode is set during defrosting.

Time chart of defrosting in HEAT mode (reverse type)

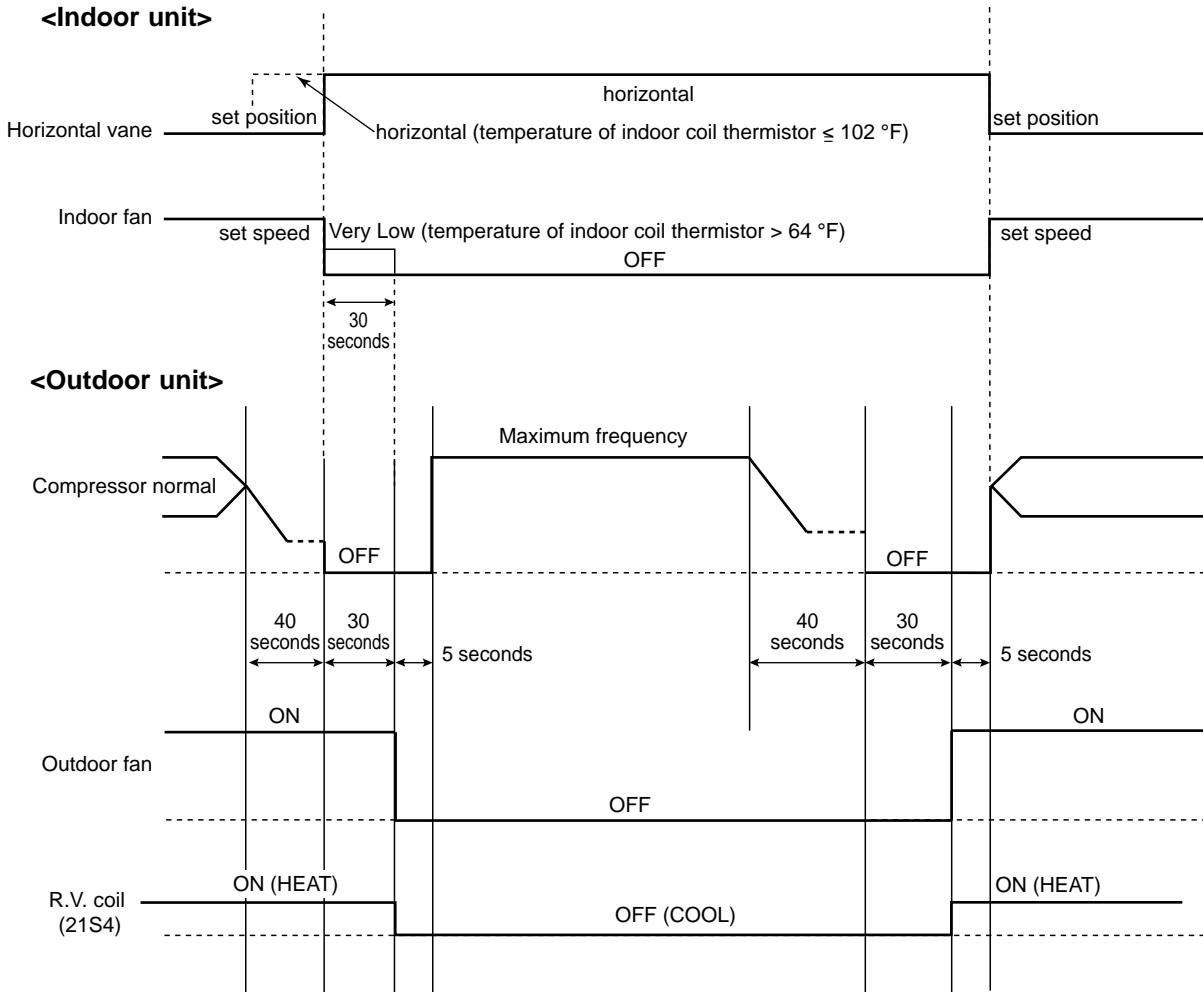

2-4. AUTO CHANGE OVER ... AUTO MODE OPERATION (MSZ)

Once desired temperature is set, unit operation is switched automatically between COOL and HEAT operation.

1. Mode selection

(1) Initial mode

At first indoor unit operates only indoor fan with outdoor unit OFF for 3 minutes to detect present room temperature. Following the conditions below, operation mode is selected.

- ① If the room temperature thermistor reads more than set temperature, COOL mode is selected.
- ② If the room temperature thermistor reads set temperature or less, HEAT mode is selected.

(2) Mode change

In case of the following conditions, the operation mode is changed.

- ① COOL mode changes to HEAT mode when 15 minutes have passed with the room temperature 4 °F below the set temperature.
- ② HEAT mode changes to COOL mode when 15 minutes have passed with the room temperature 4 °F above the set temperature.

In the other cases than the above conditions, the present operation mode is continued.

NOTE1: Mode selection is performed when multi standby (refer to **NOTE2**) is released and the unit starts operation with ON-timer.

NOTE2: If two or more indoor units are operating in multi system, there might be a case that the indoor unit, which is operating in AUTO (□), cannot change over the other operating mode (COOL ↔ HEAT) and becomes a state of standby.

(3) Indoor fan control/ Vane control

As the indoor fan speed and the horizontal vane position depend on the selected operation mode, when the operation mode changes over, they change to the exclusive ones.

2-5. OUTDOOR FAN MOTOR CONTROL

Fan speed is switched according to the compressor frequency.

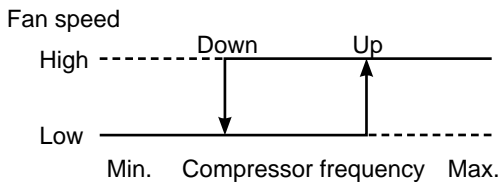

<Relation between compressor frequency and fan speed>

	Compressor frequency (Hz)	
	Down	Up
MUZ-A MUY-A	33	44
MUZ-FD	33	44
MUZ-D MUY-D	39	54

2-6. AUTO VANE OPERATION

1. Horizontal vane

(1) Cold air prevention in HEAT operation (**MUZ**)

When any of the following conditions occurs in HEAT operation, the vane angle changes to Horizontal position automatically to prevent cold air blowing on users.

- ① Compressor is not operating.
- ② Defrosting is performed.
- ③ Indoor coil thermistor temperature does not exceed 102 °F within about 3 minutes after compressor starts.

NOTE: When 2 or more indoor units are operated with multi outdoor unit, even if any indoor unit turns thermostat off, this control doesn't work in the indoor unit.

(2) ECONO COOL (⚙) operation (ECONomical operation)

When ECONO COOL button is pressed in COOL mode, set temperature is automatically set 3.6 °F higher than that in COOL mode.

Also the horizontal vane swings in various cycle according to the temperature of indoor heat exchanger (indoor coil thermistor).

SWING operation makes you feel cooler than set temperature. So, even though the set temperature is higher than that in COOL mode, the air conditioner can keep comfort. As a result, energy can be saved.

ECONO COOL operation is cancelled when ECONO COOL button is pressed once again or VANE CONTROL button is pressed or change to other operation mode.

<SWING operation>

In swing operation of ECONO COOL operation mode, the initial air flow direction is adjusted to "Horizontal". According to the temperature of indoor coil thermistor RT12 at starting of this operation, next downward blow time is decided. Then when the downward blow has been finished, next horizontal blow time is decided.

For initial 10 minutes the swing operation is performed in table G~H for quick cooling.

Also, after 10 minutes when the difference of set temperature and room temperature is more than 3.6 °F, the swing operation is performed in table D~H for more cooling.

The air conditioner repeats the swing operation in various cycle as follows.

	Temperature of indoor coil thermistor (°F)	Downward blow time (second)	Horizontal blow time (second)
A	59 or less	2	23
B	59 to 63	5	20
C	63 to 64	8	17
D	64 to 68	11	14
E	68 to 70	14	11
F	70 to 72	17	8
G	72 to 75	20	5
H	more than 75	23	2

2-7. INVERTER SYSTEM CONTROL

2-7-1. Inverter main power supply circuit

MUZ-A09/12/15/17

MUY-A15/17

MUZ-FD

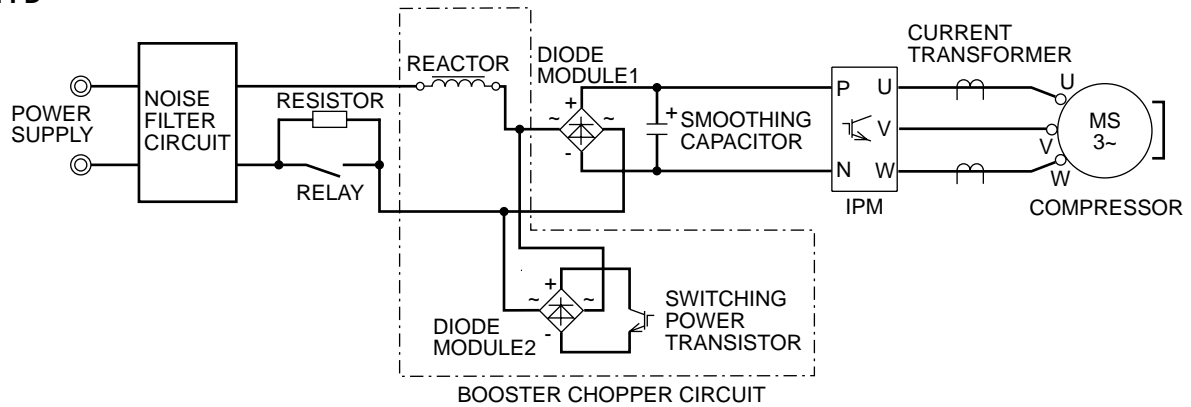

Function of main parts

NAME	FUNCTION
INTELLIGENT POWER MODULE (IPM)	It supplies three-phase AC power to compressor.
SMOOTHING CAPACITOR	It stabilizes the DC voltage and supply it to IPM.
CURRENT TRANSFORMER	It measures the current of the compressor motor.
DIODE MODULE 1	It converts the AC voltage to DC voltage.
RESISTOR	It absorbs the rush current not to run into the main power supply circuit when the electricity turns ON.
RELAY	It short-circuits the resistance which restricts rush current during the normal operation after the compressor startup.
BOOSTER CHOPPER CIRCUIT	DIODE MODULE 2
	SWITCHING POWER TRANSISTOR
	REACTOR
It improves power factor. It controls the bus-bar voltage.	

MUZ-A24
MUY-A24
MUZ-D
MUY-D

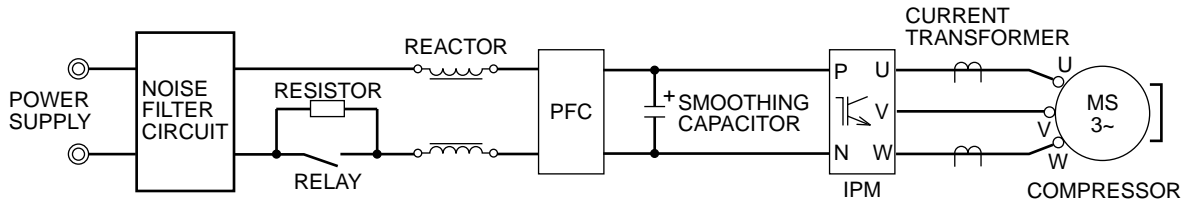

Function of main parts

NAME	FUNCTION
INTELLIGENT POWER MODULE (IPM)	It supplies three-phase AC power to compressor.
SMOOTHING CAPACITOR	It stabilizes the DC voltage and supplies it to IPM.
CURRENT TRANSFORMER	It measures the current of the compressor motor. It measures the current of the main power supply circuit.
REACTOR	It rectifies AC, controls its voltage and improves the power factor of power supply.
POWER FACTOR CORRECTION MODULE (PFC)	
RESISTOR	It restricts rush current with the resistance.
RELAY	It short-circuits the resistance which restricts rush current during the compressor operates.

2-7-2. Outline of main power supply circuit

MUZ-A09/12/15/17 MUY-A15/17 MUZ-FD

1. At the start of operation

Main power supply circuit is formed when RELAY is turned ON at COMPRESSOR startup.

To prevent rush current from running into the circuit when power supply is turned ON,

RESISTOR is placed in sub circuit.

2. At normal operation

① When AC runs into POWER P.C. board, its external noise is eliminated in NOISE FILTER CIRCUIT.

② After noise is eliminated from AC, it is rectified to DC by DIODE MODULE 1.

③ DC voltage, to which AC has been rectified by process ②, is stabilized by SMOOTHING CAPACITOR and supplied to IPM.

④ DC voltage, which has been stabilized in process ③, is converted to three-phase AC by IPM and supplied to COMPRESSOR.

⑤ CURRENT TRANSFORMER, which is placed in the power supply circuit to COMPRESSOR, are used to measure the value of phase current and locate the polar direction of rotor with algorithm. PWM (Pulse width modulation) controls impressed voltage and frequency with those information.

3. Purpose of PAM adoption

PAM : Pulse Amplitude Modulation

PAM has been adopted for the efficiency improvement and the adaptation to IEC harmonic current emission standard

Outline of simple partial switching method

In conventional inverter models, DIODE MODULE rectifies AC voltage to DC voltage, SMOOTHING CAPACITOR makes its DC waveform smooth, and IPM converts its DC voltage to imitated AC voltage again in order to drive the compressor motor.

However, it has been difficult to meet IEC harmonic current emission standard by above circuit because harmonic gets generated in the input current waveform and power factor gets down. The simple partial switching method with PAM, which has been adopted this time, places and utilizes BOOSTER CHOPPER CIRCUIT before rectifying AC voltage in the general passive-method converter circuit. As harmonic gets suppressed and the peak of waveform gets lower by adding BOOSTER CHOPPER CIRCUIT as mentioned above and by synchronizing the timing of switching with the zero-cross point of waveform, the input current waveform can be improved and the requirement of IEC harmonic current emission standard can be satisfied.

Since the switching synchronized with the zero cross point, this simple partial switching method has the feature of lower energy loss compared to active filter method. In addition, output and efficiency is enhanced by combining with vector-controlled inverter in order to boost the voltage of power supplied to IPM.

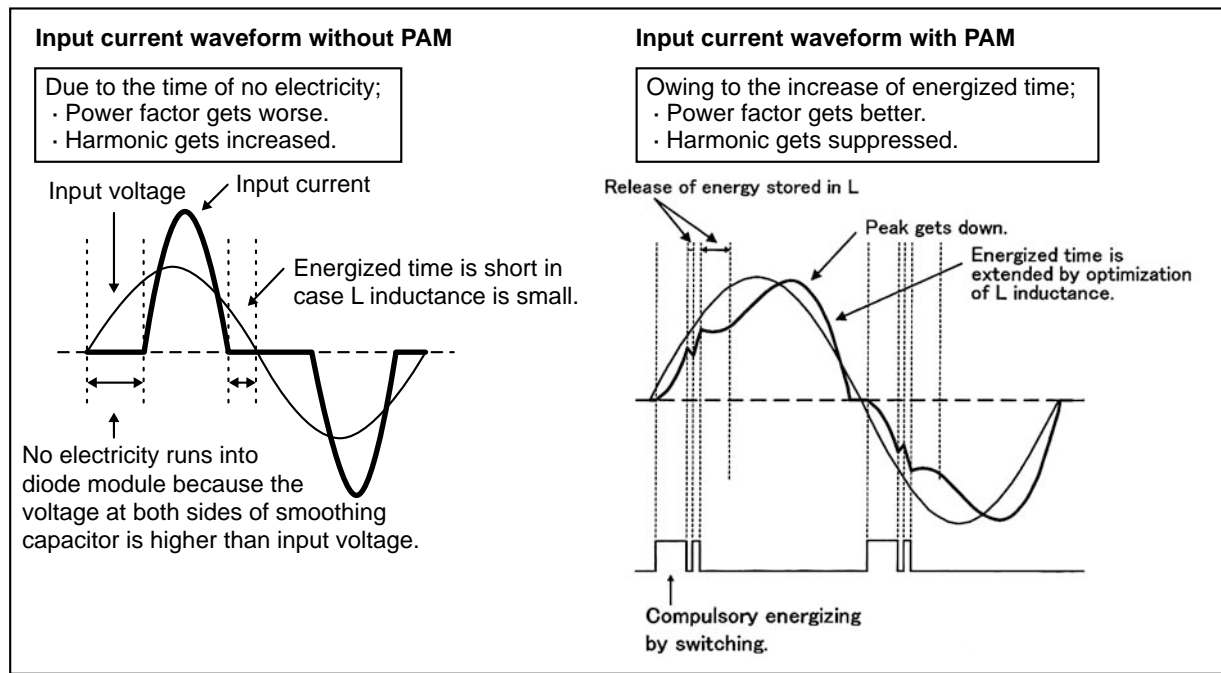

4. Intelligent power module

IPM consists of the following components

- IGBT (x6) : Converts DC waveform to three-phase AC waveform and outputs it.
- Drive Circuit : Drives transistors.
- Protection circuit : Protects transistors from overcurrent.

Since the above components are all integrated in IPM, IPM has a merit to make the control circuit simplify and miniaturize.

5. Elimination of electrical noise

NOISE FILTER CIRCUIT, which is formed by *CMC COILS capacitors placed on the POWER P.C. board, eliminates electrical noise of AC power that is supplied to main power supply circuit. And this circuit prevents the electrical noise generated in the inverter circuit from leaking out.

*CMC COILS; Common mode choke coils

MUZ-A24 MUY-A24 MUZ-D MUY-D

1. At the start of operation

Main power supply circuit is formed when RELAY is turned ON at COMPRESSOR startup.

To prevent rush current from running into the circuit when power supply is turned ON, RESISTOR are placed in sub circuit.

2. At normal operation

- ① When AC runs into noise filter P.C. board, its external noise is eliminated in NOISE FILTER CIRCUIT.
- ② After noise being eliminated from AC, it is rectified to DC by REACTOR and PFC. If the operating frequency becomes 25 Hz or more, DC voltage rises to 370 V.
- ③ DC voltage, to which has AC been rectified by process ②, is stabilized by SMOOTHING CAPACITOR and supplied to IPM.
- ④ The DC (Bus voltage), which has been stabilized in process ③, is converted to three-phase AC by IPM and supplied to COMPRESSOR.
- ⑤ CURRENT TRANSFORMER, which is placed in the power supply circuit to COMPRESSOR, are used to measure the value of phase current and locate the polar direction of rotor with algorithm. PWM (Pulse width modulation) controls impressed voltage and frequency with those information.

3. Power factor improvement

Booster coil reactor and power factor controller rectify AC to DC and control its voltage.

In the motor drive system of sine wave control, power factor can be improved by reducing harmonics. PFC and reactor stabilize the voltage of DC supplied to inverter circuit and make its waveform smooth.

4. Power transistor module

IPM consists of the following components.

- Power Transistors (x6) : Converts DC waveform to three-phase AC waveform and outputs it.
- Drive Circuit : Drives transistors.
- Protection circuit : Protects transistors from over current.

Since the above components are all integrated in IPM, IPM has a merit that can get the control circuit simplified and miniaturized.

5. Elimination of electrical noise

NOISE FILTER CIRCUIT, which is formed by *CMC COILS and capacitors placed on the noise filter P.C. board, eliminates electrical noise of AC power that is supplied to main power supply circuit. In short, common mode noise is absorbed in this circuit.

Moreover, normal mode noise is absorbed in another NOISE FILTER CIRCUIT which is formed by *NMC COILS and capacitors.

Both NOISE FILTER CIRCUIT exists for preventing the electrical noise generated in the inverter circuit from leaking out.

*CMC COILS; Common mode choke coils

*NMC COILS; Normal mode choke coils

2-7-3. Sine wave control

In these air conditioners, compressor equips brushless DC motor which doesn't have Hall element.

In short, the motor is sensorless. However, it's necessary to locate the polar direction of rotor in order to drive brushless DC motor efficiently. The general detection method of the polar direction for such a DC motor is to locate it from the voltage induced by unenergized stator.

Therefore, it is necessary to have a certain period of time in which the stator is being unenergized for the rotor position detection when the voltage of supplied power is impressed.

So the motor has been driven by square wave control (the conventional motor drive system) which energizes the motor only when the range of electrical angle is within 120° because it is forced to be unenergized within 30° at start & end of one heap in one waveform cycle (180°) when the voltage is impressed.

However, torque pulsation occurs at rotation in this method when the current-carrying phases are switched over to other phases in sequence. Therefore, sine wave control system is adopted for these air conditioners because it can make the phase-to-phase current waveform smoother (sine wave) in order to drive the motor more efficiently and smoothly.

2-7-4. Characteristics of sine wave control in case of brushless DC motor

- Although ordinary three-phase induction motor requires energy to excite the magnetic field of rotor, brushless DC motor doesn't need it. So, higher efficiency and torque are provided.
- This control provides the most efficient waveform corresponding to the rotation times of compressor motor.
- The rotation can be set to higher compared to the conventional motor drive system. So, the time in which air conditioner can be operated with energy saved is longer than conventional models. This can save annual electric consumption.
- Compared to square wave control, the torque pulsation is reduced at rotation so that the motor operates more quietly.
- Since response and efficiency of motor are enhanced in sine wave control, finer adjustment can be provided.

	DC Motor	AC Motor
Rotor	Permanent magnet is embedded	Excited by magnetic field of stator
Rotor Position Signal	Necessary	Unnecessary

※ In brushless DC motor, permanent magnet is embedded in the rotor. Therefore, it doesn't require energy to excite the rotor like AC motor does. However, it's necessary to control the frequency of three-phase AC current supplied to the stator according to the polar direction of magnet embedded in the rotor so as to drive the motor efficiently. Controlling 3 phase AC current frequency also means controlling the timing to switch the polarity of stator. Therefore, the polar direction of rotor needs to be detected.

2-7-5. Control Method of Rotation Times

Sine wave control makes the current transformers conduct real time detection of the value of the current running into the motor, locates the rotor position from the detected value, and decides if voltage should be impressed and if frequency should be changed.

Compared to the conventional control and rotor position detection method, sine wave control can provide finer adjustment of the voltage of supplied power. The value of the current running into the motor is determined by each motor characteristic.

2-8. OPERATIONAL FREQUENCY CONTROL OF OUTDOOR UNIT

1. Outline

The operational frequency is as following:

First, the target operational frequency is set based on the difference between the room temperature and the set temperature.

Second, the target operational frequency is regulated by discharge temperature protection, high pressure protection, electric current protection and overload protection and also by the maximum/minimum frequency.

2. Maximum/minimum frequency in each operation mode.

Unit: Hz

Applied model	COOL		HEAT (MUZ)		DRY	
	Minimum frequency	Maximum frequency	Minimum frequency	Maximum frequency	Minimum frequency	Maximum frequency
MUZ-A09	32	70	32	76	32	57
MUZ-A12	32	73	32	71	32	57
MUZ-A15 MUY-A15	10	82	15	93	10	68
MUZ-A17 MUY-A17	10	87	15	93	10	68
MUZ-A24 MUY-A24	15	110	15	108	15	102
MUZ-FD09	10	52	10	100	10	41
MUZ-FD12	10	62	10	100	10	41
MUZ-D30	20	84	20	87	20	83
MUY-D36	20	79	—	—	20	79
MUZ-D36	20	91	20	94	20	83
MUY-D36	20	92	—	—	20	79

※ The operation frequency in COOL mode is restricted by the upper limit frequency after 1 hour or 0.5 ~ 1 hour as shown below for dew prevention.

It is rated frequency or less.

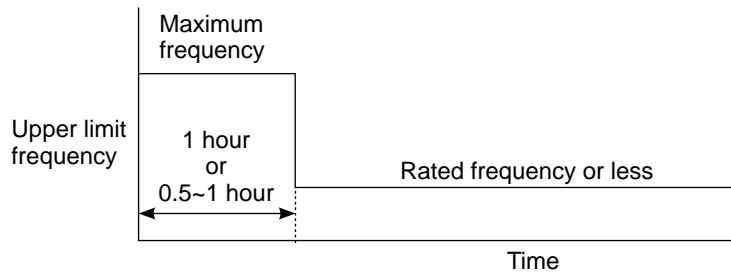

2-9. EXPANSION VALVE CONTROL (LEV CONTROL)

(1) Outline of LEV control

The LEV basic control is comprised of setting LEV opening degree to the standard opening °F set for each operational frequency of the compressor. However, when any change in indoor/outdoor temperatures or other factors cause air conditioning load fluctuation, the LEV control also works to correct LEV opening degree based on discharge temperature (Shell temperature) of the compressor, developing the unit's performance.

Standard specification	Control range	Minimum : 33 pulse (MUZ-A09/12/15/17 MUY-A15/17) 59 pulse (MUZ-A24 MUY-A24) 54 pulse (MUZ-FD) 58 pulse (MUZ-D MUY-D) Maximum : 500 pulse
	Actuating speed	Open : 40 pulse/second Close : 90 pulse/second.
	Opening degree adjustment	LEV opening degree is always adjusted in opening direction. (When reducing the opening degree, LEV is once over-closed, and then adjusted to the proper degree by opening.
General operation	Unit OFF	LEV remains at maximum opening degree (reaches maximum opening degree approximate in 15 minutes after compressor stops)
	Remote controller ON	LEV is positioned. (first full-closed at zero pulse and then positioned.)
	COOL · DRY MODE During 1 to 5 minutes after compressor starts	LEV is fixed to standard opening degree according to operational frequency of compressor.
	HEAT MODE During 1 to 15 minutes after compressor starts	
	More than 5 (COOL, DRY), 15 (HEAT (MUZ)) minutes have passed since compressor start-up	LEV opening degree is corrected to get target discharge temperature of compressor. (For lower discharge temperature than target temperature, LEV is corrected in closing direction.) (For higher discharge temperature than target temperature, LEV is corrected in opening direction.) ※It may take more than 30 minutes to reach target temperature, depending on operating conditions.
	Thermostat OFF	LEV is adjusted to exclusive opening degree for thermostat OFF.
	Thermostat ON	LEV is controlled in the same way as that after the compressor has started up.
Defrosting in HEAT mode	LEV is adjusted to open 500 pulse.	

(2) Time chart

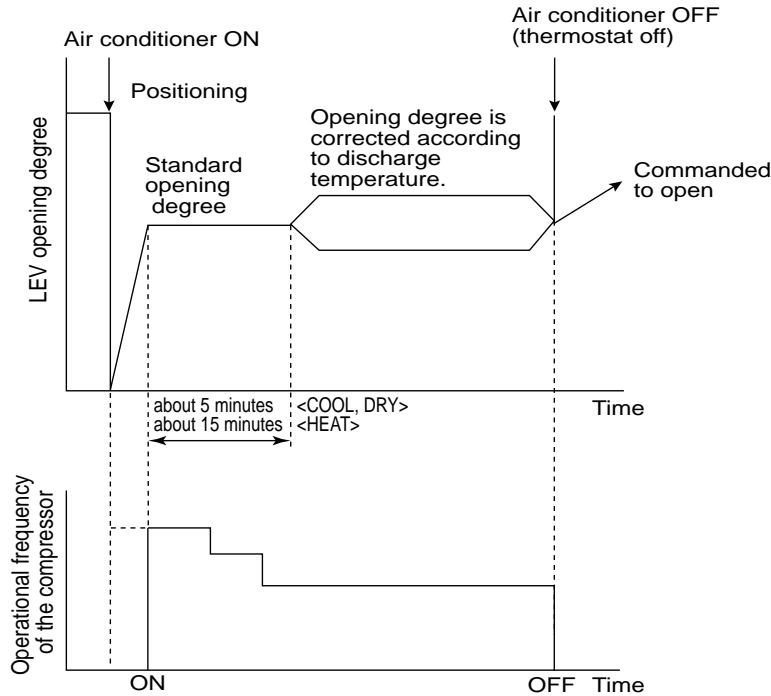

(3) Control data

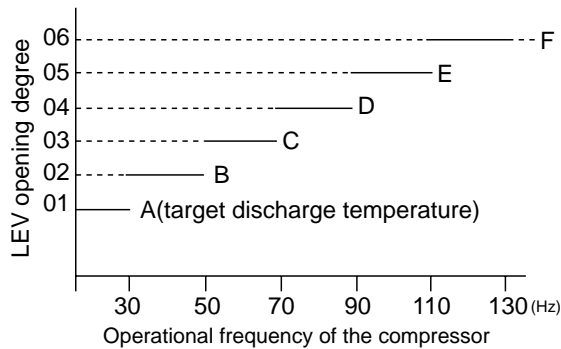

(a) Reference value of target discharge temperature (COOL / HEAT (MUZ) °F)

Applied model		A	B	C	D	E	F
MUZ-A09/12	COOL	122	127	140	151	158	158
	HEAT	113	126	138	154	169	169
MUZ-A15/17 MUY-A15/17	COOL	129	136	147	158	158	158
	HEAT	120	136	151	165	180	185
MUZ-A24 MUY-A24	COOL	140	140	140	145	147	153
	HEAT	140	145	149	153	158	158
MUZ-FD	COOL	120	131	142	153	162	169
	HEAT	109	124	138	156	167	176
MUZ-D MUY-D	COOL	126	135	149	167	183	187
	HEAT	131	140	149	154	162	167

In COOL operation, the two indoor coil thermistors (one main and one sub) sense temperature ununiformity (super heat) at the heat exchanger, and when temperature difference have developed, the indoor coil thermistors adjust LEV opening degree to get approximate 10 degrees lower temperature than the target temperature in the table above, thus diminishing super heat.

(b) Reference value of LEV standard opening degree (pulse)

Applied model		A	B	C	D	E	F
MUZ-A09/12	COOL	130	190	240	260	260	260
	HEAT	100	130	170	210	230	230
MUZ-A15/17	COOL	290	300	350	350	370	370
MUY-A15/17	HEAT	130	150	220	250	280	300
MUZ-A24	COOL	150	166	186	206	230	260
MUY-A24	HEAT	130	150	170	196	210	226
MUZ-FD	COOL	180	240	300	320	320	320
	HEAT	130	180	240	270	300	300
MUZ-D	COOL	150	170	210	250	280	300
MUY-D	HEAT	100	120	140	190	240	280

MXZ-A•NA

3-1. INVERTER SYSTEM CONTROL

3-1-1. Inverter main power supply circuit

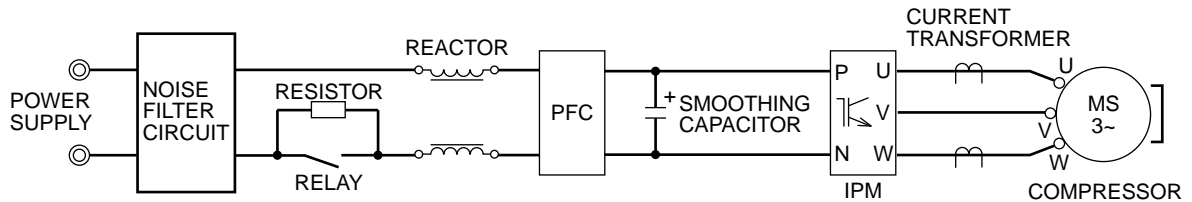

Function of main parts

NAME	FUNCTION
INTELLIGENT POWER MODULE (IPM)	It supplies three-phase AC power to compressor.
SMOOTHING CAPACITOR	It stabilizes the DC voltage and supplies it to IPM.
CURRENT TRANSFORMER	It measures the current of the compressor motor. It measures the current of the main power supply circuit.
REACTOR	It rectifies AC, controls its voltage and improves the power factor of power supply.
POWER FACTOR CORRECTION MODULE (PFC)	
RESISTOR	It restricts rush current with the resistance.
RELAY	It short-circuits the resistance which restricts rush current during the compressor operates.

3-1-2. Outline of main power supply circuit

1. At the start of operation

Main power supply circuit is formed when RELAY is turned ON at COMPRESSOR startup.

To prevent rush current from running into the circuit when power supply is turned ON, RESISTOR are placed in sub circuit.

2. At normal operation

- ① When AC runs into noise filter P.C. board, its external noise is eliminated in NOISE FILTER CIRCUIT.
- ② After noise being eliminated from AC, it is rectified to DC by REACTOR and PFC. If the operating frequency becomes 25 Hz or more, DC voltage rises to 370 V.
- ③ DC voltage, to which has AC been rectified by process ②, is stabilized by SMOOTHING CAPACITOR and supplied to IPM.
- ④ The DC (Bus voltage), which has been stabilized in process ③, is converted to three-phase AC by IPM and supplied to COMPRESSOR.
- ⑤ CURRENT TRANSFORMER, which is placed in the power supply circuit to COMPRESSOR, are used to measure the value of phase current and locate the polar direction of rotor with algorithm. PWM (Pulse width modulation) controls impressed voltage and frequency with those information.

3. Power factor improvement

Booster coil reactor and PFC rectify AC to DC and control its voltage.

In the motor drive system of sine wave control, power factor can be improved by reducing harmonics. PFC and reactor stabilize the voltage of DC supplied to inverter circuit and make its waveform smooth.

4. Power transistor module

IPM consists of the following components.

- Power Transistors (x6) : Converts DC waveform to three-phase AC waveform and outputs it.
- Drive Circuit : Drives transistors.
- Protection circuit : Protects transistors from over current.

Since the above components are all integrated in IPM, IPM has a merit that can get the control circuit simplified and miniaturized.

5. Elimination of electrical noise

NOISE FILTER CIRCUIT, which is formed by *CMC COILS and capacitors placed on the noise filter P.C. board, eliminates electrical noise of AC power that is supplied to main power supply circuit. In short, common mode noise is absorbed in this circuit.

Moreover, normal mode noise is absorbed in another NOISE FILTER CIRCUIT which is formed by *NMC COILS and capacitors.

Both NOISE FILTER CIRCUIT exists for preventing the electrical noise generated in the inverter circuit from leaking out.

*CMC COILS; Common mode choke coils

*NMC COILS; Normal mode choke coils

3-1-3. Sine wave control

In these air conditioners, compressor equips brushless DC motor which doesn't have Hall element.

In short, the motor is sensorless. However, it's necessary to locate the polar direction of rotor in order to drive brushless DC motor efficiently. The general detection method of the polar direction for such a DC motor is to locate it from the voltage induced by unenergized stator.

Therefore, it is necessary to have a certain period of time in which the stator is being unenergized for the rotor position detection when the voltage of supplied power is impressed.

So the motor has been driven by square wave control (the conventional motor drive system) which energizes the motor only when the range of electrical angle is within 120° because it is forced to be unenergized within 30° at start & end of one heap in one waveform cycle (180°) when the voltage is impressed.

However, torque pulsation occurs at rotation in this method when the current-carrying phases are switched over to other phases in sequence. Therefore, sine wave control system is adopted for these air conditioners because it can make the phase-to-phase current waveform smoother (sine wave) in order to drive the motor more efficiently and smoothly.

3-1-4. Characteristics of sine wave control in case of brushless DC motor

- Although ordinary three-phase induction motor requires energy to excite the magnetic field of rotor, brushless DC motor doesn't need it. So, higher efficiency and torque are provided.
- This control provides the most efficient waveform corresponding to the rotation times of compressor motor.
- The rotation can be set to higher compared to the conventional motor drive system. So, the time in which air conditioner can be operated with energy saved is longer than conventional models. This can save annual electric consumption.
- Compared to square wave control, the torque pulsation is reduced at rotation so that the motor operates more quietly.
- Since response and efficiency are enhanced in sine wave control, finer adjustment can be provided.

	DC Motor	AC Motor
Rotor	Permanent magnet is embedded	Excited by magnetic field of stator
Rotor Position Signal	Necessary	Unnecessary

※ In brushless DC motor, permanent magnet is embedded in the rotor. Therefore, it doesn't require energy to excite the rotor like AC motor does. However, it's necessary to control the frequency of three-phase AC current supplied to the stator according to the polar direction of magnet embedded in the rotor so as to drive the motor efficiently. Controlling 3 phase AC current frequency also means controlling the timing to switch the polarity of stator. Therefore, the polar direction of rotor needs to be detected.

3-1-5. Control Method of Rotation Times

Sine wave control makes the current transformers conduct real time detection of the value of the current running into the motor, locates the rotor position from the detected value and decides if voltage should be impressed and if frequency should be changed.

Compared to the conventional control and rotor position detection method, sine wave control can provide finer adjustment of the voltage of supplied power. The value of the current running into the motor is determined by each motor characteristic.

3-2. EXPANSION VALVE CONTROL (LEV CONTROL)

Linear expansion valve (LEV) is controlled by “Thermostat ON” commands given from each unit.

Indoor unit status	LEV opening
Stop of all indoor unit	Opening before stop → 500 pulse in 15 minutes
When outdoor unit is operating, some indoor units stop and some operate.	COOL : 5 pulse (full closed) HEAT : (MXZ-2A / 3A30NA) : 140 pulse (slightly opened) : (MXZ-3A30NA-□1 / 4A) : 100 → 59 pulse
Thermostat OFF in COOL or DRY mode	When the outdoor unit operates (When the other indoor unit operates) : 5 pulse. When outdoor unit stops. (When the other indoor unit stops or thermo off) : Maintain LEV opening before stop → 500 pulse in 15 minutes
Thermostat ON in COOL or DRY mode	<ul style="list-style-type: none"> • LEV opening for each indoor unit is determined by adding adjustment in accordance with the number of operating unit and the capacity class to standard opening, based on the operation frequency: Ex.) Opening 130 pulse in standard opening 1 → Minimum 80 pulse, Maximum 205 pulse. (Capacity code 4 at 1 unit operation) (Capacity code 1 at 3 units operation) • After starting operation, adjustment in accordance with intake super heat, discharge temperature is included in standard opening. ※1 <p>NOTE: LEV opening in each frequency at DRY operation and COOL operation is the same. However, velocity and compressor operation frequency controls are different. See 3-3. OPERATIONAL FREQUENCY RANGE (As far as the indoor unit velocity control goes, refer to DRY operation in MICRO-PROCESSOR CONTROL in indoor unit.)</p>
Thermostat OFF in HEAT mode	<ul style="list-style-type: none"> • When the outdoor unit operates. (When the other indoor unit operates) : 140 pulse. • When the outdoor unit stops. (When the other indoor unit stops or thermo off) : Maintain LEV opening before stop → 500 pulse in 15 minutes. “
Thermostat ON in HEAT mode	<ul style="list-style-type: none"> • LEV opening for each indoor unit is determined by adding adjustment in accordance with the number of operating unit and the capacity class to standard opening, based on the operation frequency: Ex.) Opening 120 pulse in standard opening 1 → Minimum 70 pulse, Maximum 165 pulse. (Capacity code 4 at 1 unit operation) (Capacity code 1 at 3 units operation) • After starting operation, opening becomes the one that adjustment in accordance with discharge temperature was added to basic opening. ※1 “

※1 LEV opening when the outdoor unit is operating: Upper limit 500 pulse, Lower limit 53pulse (MXZ-2A / 3A30NA), 59 pulse (MXZ-3A30NA-□1 / 4A).

MXZ-2A20NA/3A30NA

The table below shows the role of Exclusive LEV and Receiver LEV in each operation mode.

		Circulation Amount Control	Capacity Distribution	Discharge Temperature Protection	High Pressure Protection	※Evaporation Temperature Protection
COOL	Exclusive LEV	○	○	○	○	○
	Receiver LEV	✕	✕	○	○	○
HEAT	Exclusive LEV	✕	○	○	○	—
	Receiver LEV	○	✕	○	○	—

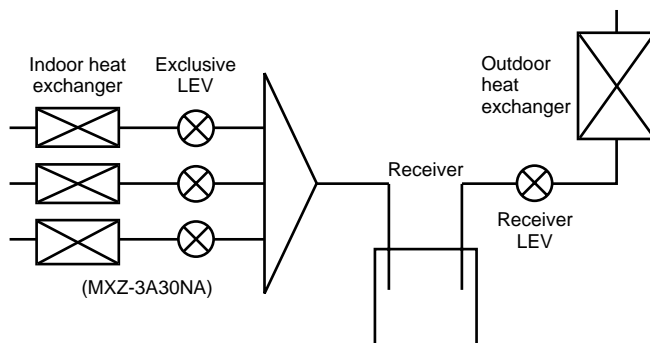

※In COOL mode, the two indoor coil thermistors (one main and one sub) sense temperature ununiformity (super heat) at the heat exchanger, and when temperature difference have developed, the indoor coil thermistors adjust LEV opening to diminish the super heat. This action is called Evaporation Temperature Protection.

The opening pulse of the Receiver LEV is fixed to the standard No.3 in cooling operation, and so is that of each Exclusive LEV in heating operation.

However the opening pulse will be changed to the standard No.4 or No.5 when the discharge temperature protection or high-pressure protection is working.

In addition to that, it will also be changed to standard No.2 or No.1 when the opening pulse of the each Exclusive LEV becomes 100 pulse or less in cooling operation or so does that of Receiver LEV in heating operation.

<MXZ-2A20NA>

Number of operating indoor units	LEV opening (pulse)			
	COOL		HEAT	
	1 unit	2 units	1 unit	2 units
Standard No. 1	200	150	120	120
2	300	320	140	140
3	400	360	160	160
4	450	410	220	220
5	500	500	280	280

<MXZ-3A30NA>

Number of operating indoor units	LEV opening (pulse)					
	COOL			HEAT		
	1 unit	2 units	3 units	1 unit	2 units	3 units
Standard No. 1	150	250	250	250	250	250
2	250	320	320	300	300	300
3	350	360	370	450	380	380
4	400	410	420	460	400	390
5	450	460	470	470	450	440

Determination of LEV standard opening in each indoor unit

- The standard opening is on the straight line, which connects an each standard point in the section where divided into seven according to the operation frequency of compressor as shown in the figure below.
(LEV opening is controlled in proportion to the operation frequency.)

NOTE: Opening is adjusted at the standard opening according to the indoor unit conditions.

However, inclination of standard opening in each point of opening does not change with the original curve.

- Add opening provided in Difference in capacity in the table below to the standard opening from 1 to 8, when capacity of the indoor unit is excluding code 1.
- Add opening provided in Difference in operation number in the table below to determined LEV opening for each indoor unit, when 2 or 3 indoor units are operated at the same time.

NOTE: Even when the adjusted standard opening exceeds the driving range from 59 to 500 pulse, actual driving output opening is in a range from 59 to 500 pulse.

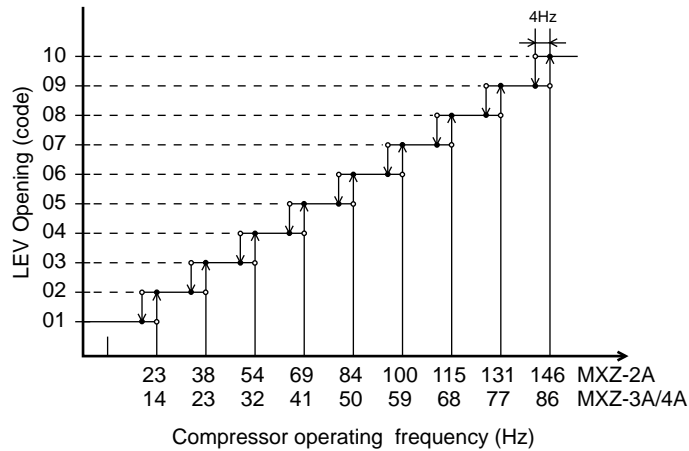

MXZ-2A20NA

LEV Opening (code)	Standard opening (pulse)									
	1	2	3	4	5	6	7	8	9	10
COOL	120	130	136	146	156	160	170	180	190	200
HEAT	100	110	120	130	146	160	170	180	190	200

	Difference in capacity							Difference in operation number
	Code3,4	Code5,6	Code7,8	Code9,10	Code11,12	Code13,14	Code15or above	2
COOL	3	6	9	12	15	25	35	-20
HEAT	3	6	9	52	55	65	75	0

MXZ-3A30NA

LEV Opening (code)	Standard opening (pulse)									
	1	2	3	4	5	6	7	8	9	10
COOL	126	130	134	138	140	142	182	228	296	310
HEAT	140	146	150	170	180	200	224	244	272	280

	Difference in capacity							Difference in operation number	
	Code3,4	Code5,6	Code7,8	Code9,10	Code11,12	Code13,14	Code15or above	2	3
COOL	3	6	9	12	15	25	35	-20	-30
HEAT	3	6	9	52	55	65	75	0	0

MXZ-2A20NA-1**Exclusive LEV**

	Standard opening (pulse)									
LEV Opening (code)	1	2	3	4	5	6	7	8	9	10
COOL	120	130	136	146	156	160	170	180	190	200
HEAT	248	248	258	266	274	280	286	292	300	306

	Difference in capacity							Difference in operation number	
	Code3,4	Code5,6	Code7,8	Code9,10	Code11,12	Code13,14	Code15or above	2	
COOL	3	6	9	12	15	25	35		-20
HEAT	3	6	9	52	55	65	75		30

Receiver LEV

	Standard opening (pulse)									
LEV Opening (code)	1	2	3	4	5	6	7	8	9	10
COOL	140	150	160	170	180	190	200	200	200	200
HEAT	80	84	90	110	120	130	140	150	160	170

Operation number	Difference in operation number
	2
COOL	-20
HEAT	30

MXZ-3A30NA-1 MXZ-4A36NA**Exclusive LEV**

	Standard opening (pulse)									
LEV Opening (code)	1	2	3	4	5	6	7	8	9	10
COOL	126	130	134	138	150	160	170	180	190	200
HEAT	248	248	258	266	274	280	286	292	300	306

	Difference in capacity							Difference in operation number		
	Code3,4	Code5,6	Code7,8	Code9,10	Code11,12	Code13,14	Code15or above	2	3	4(MXZ-4A)
COOL	3	6	9	12	15	25	35	-20	-30	-30
HEAT	3	6	9	52	55	65	75	-4	-8	-12

Receiver LEV

	Standard opening (pulse)									
LEV Opening (code)	1	2	3	4	5	6	7	8	9	10
COOL	270	280	290	300	310	320	330	340	350	360
HEAT	140	152	160	170	180	200	224	244	274	280

Operation number	Difference in operation number		
	2	3	4(MXZ-4A)
COOL	28	56	84
HEAT	-45	-60	-60

Capacity code	4	7	9	10	12
Indoor unit	09	12	15	17	24

<Correction>

	COOL	DRY	HEAT
① Discharge temperature	●* 2	●* 2	●
② Each correction • (Each gas pipe temperature thermistor - Minimum gas pipe temperature thermistor)* 1 • (Main indoor coil thermistor - Sub indoor coil thermistor)	●	●	—

* 1 Perform this, when number of operation units is 2 units or more.

MXZ-2A20NA-□1, **MXZ-3A30NA-□1** and **MXZ-4A36NA** are excluded.

* 2 Correct the LEV opening by discharge temperature.

(1) LEV opening correction by discharge temperature

The target discharge temperature is determined according to frequency zone and number of operation unit of the compressor.

MXZ-2A20NA

Operation frequency of compressor (Hz)	Target discharge temperature (°F)			
	COOL		HEAT	
	Number of operating unit			
	1 unit	2 units	1 unit	2 units
Minimum ~ 23	95	136.4	122	122
24 ~ 38	104	140	132.8	122
39 ~ 54	120.2	149	140	132.8
55 ~ 69	136.4	154.4	140	140
70 ~ 85	149	158	140	140
86 ~ Maximum	158	158	140	140

MXZ-2A20NA-□1

Operation frequency of compressor (Hz)	Target discharge temperature (°F)			
	COOL		HEAT	
	Number of operating unit			
	1 unit	2 units	1 unit	2 units
Minimum ~ 23	95	136.4	122	122
24 ~ 38	104	140	132.8	122
39 ~ 54	120.2	149	140	132.8
55 ~ 69	136.4	154.4	145.4	140
70 ~ 85	149	158	150.8	140
86 ~ Maximum	158	158	152.6	140

MXZ-3A30NA

Operation frequency of compressor (Hz)	Target discharge temperature (°F)					
	COOL			HEAT		
	Number of operating unit					
	1 unit	2 units	3 units	1 unit	2 unit	3 units
Minimum ~ 14	95	131	134.6	125.6	143.6	122
15 ~ 23	104	131	134.6	136.4	150.8	131
24 ~ 32	120.2	136.4	145.4	149	165.2	140
33 ~ 41	136.4	140	149	154.4	172.4	152.6
42 ~ 50	149	149	158	154.4	172.4	161.6
51 ~ 59	154.4	154.4	163.4	154.4	172.4	168.8
60 ~ 68	158	158	167	154.4	172.4	168.8
69 ~ 77	167	163.4	176	154.4	172.4	168.8
78 ~ 86	167	167	179.6	154.4	172.4	168.8
87 ~ Maximum	167	176	179.6	172.4	172.4	168.8

MXZ-3A30NA-1 MXZ-4A36NA

Operation frequency of compressor (Hz)	Target discharge temperature (°F)							
	COOL				HEAT			
	Number of operating unit							
	1 unit	2 units	3 units	4 units (MXZ-4A36)	1 unit	2 unit	3 units	4 units (MXZ-4A36)
Minimum ~ 14	95	131	134.6	140	125.6	143.6	122	122
15 ~ 23	107.6	131	134.6	140	136.4	150.8	131	122
24 ~ 32	120.2	136.4	145.4	140	149	165.2	140	122
33 ~ 41	136.4	140	149	143.6	154.4	172.4	152.6	122
42 ~ 50	149	149	158	149	154.4	172.4	161.6	131
51 ~ 59	154.4	154.4	163.4	158	154.4	172.4	168.8	140
60 ~ 68	158	158	167	158	154.4	172.4	168.8	140
69 ~ 77	167	163.4	176	161.6	154.4	172.4	168.8	140
78 ~ 86	167	167	179.6	161.6	154.4	172.4	168.8	140
87 ~ Maximum	167	176	179.6	161.6	172.4	172.4	168.8	140

Correct the LEV opening according to the difference between target discharge temperature and discharge temperature.

MXZ-2A

Discharge temperature (°F)	LEV opening correction (pulse)	
	COOL	HEAT
More than Target discharge temperature+18	5	8
Target discharge temperature + 18 to Target discharge temperature + 9	4	3
Target discharge temperature + 9 to Target discharge temperature + 3.6	2	1
Target discharge temperature + 3.6 to Target discharge temperature - 3.6	0	0
Target discharge temperature - 3.6 to Target discharge temperature - 9	-1	-1
Target discharge temperature - 9 to Target discharge temperature - 18	-3	-2
Target discharge temperature - 18 or less	-4	-3

MXZ-3A MXZ-4A

Discharge temperature (°F)	LEV opening correction (pulse)	
	COOL	HEAT
More than Target discharge temperature + 21.6	4	6
Target discharge temperature + 21.6 to Target discharge temperature + 9	2	2
Target discharge temperature + 9 to Target discharge temperature + 5.4	1	1
Target discharge temperature + 5.4 to Target discharge temperature - 5.4	0	0
Target discharge temperature - 5.4 to Target discharge temperature - 9	-1	-1
Target discharge temperature - 9 to Target discharge temperature - 21.6	-3	-2
Target discharge temperature - 21.6 or less	-8	-8

(2) Separate correction (COOL, DRY)

(Correction by the separate super heat)

a) Correct the LEV separately by temperature difference between each gas pipe temperature and the minimum gas pipe temperature of all.

① Calculate each super heat of the unit from the expression below;

$$\text{(Super heat)} = \text{(Each gas pipe temperature)} - \text{(Minimum gas pipe temperature)}$$

② Separate correction is performed according to each super heat in the table below.

MXZ-2A20NA

Superheat	LEV opening correction (pulse)
more than 16.2	3
10.8 to 16.2	2
5.4 to 10.8	1
5.4 or less	0

MXZ-3A30NA

Superheat	LEV opening correction (pulse)
more than 16.2	12
10.8 to 16.2	8
5.4 to 10.8	4
5.4 or less	0

b) Correct the LEV separately by temperature difference “ ΔRT ” between main/sub indoor coil thermistor.

ΔRT	LEV opening correction (pulse)
$10.8 \leq \Delta RT$	2
$7.2 \leq \Delta RT < 10.8$	1
$\Delta RT < 7.2$	1

In addition, decrease the target discharge temperature corresponding ΔRT .

ΔRT	Temperature to be decreased (°F)
$10.8 \leq \Delta RT$	18
$7.2 \leq \Delta RT < 10.8$	9
$\Delta RT < 7.2$	9

3-3. OPERATIONAL FREQUENCY RANGE

MXZ-2A20NA

Number of operating unit	Capacity code	COOL (Hz)		DRY (Hz)	HEAT (Hz)		
		Min.	Max.		Min.	Max.	Defrost
1	4	20	65	25	48	92	92
	7	20	85	30	48	92	92
	9,10	20	100	75	48	100	100
	12	20	100	75	48	100	100
2	8 ~ 10	30	105	52	58	112	100
	11 ~ 13	30	105	52	58	112	100
	14 ~ 16	30	105	52	58	112	100
	17 ~	20	105	100	58	112	100

MXZ-2A20NA-1

Number of operating unit	Capacity code	COOL (Hz)		DRY (Hz)	HEAT (Hz)		
		Min.	Max.		Min.	Max.	Defrost
1	4	20	65	35	48	92	92
	7	20	85	34	48	92	92
	9,10	20	93	75	48	92	92
	12	20	93	75	48	92	92
2	8 ~ 10	30	93	52	58	110	101
	11 ~ 13	30	93	52	58	110	101
	14 ~ 16	30	93	52	58	110	101
	17 ~	30	93	93	58	110	101

MXZ-3A30NA

Number of operating unit	Capacity code	COOL (Hz)		DRY (Hz)	HEAT (Hz)		
		Min.	Max.		Min.	Max.	Defrost
1	4	15	58	20	22	48	48
	7	15	58	25	22	48	48
	9,10	15	62	44	22	62	58
	12	15	68	44	22	90	58
2	8 ~ 10	24	80	31	35	70	58
	11 ~ 13	24	80	31	35	90	58
	14 ~ 16	24	80	31	35	94	58
	17 ~	24	80	59	35	94	58
3	12 ~	52	90	65	39	94	58

MXZ-3A30NA-□ MXZ-4A

Number of operating unit	Capacity code	COOL (Hz)		DRY (Hz)	HEAT (Hz)		
		Min.	Max.		Min.	Max.	Defrost
1	4	25	58	25	20	70	58
	7	25	58	25	20	70	58
	9,10	25	71	25	20	80	58
	12	25	80	35	20	80	58
2	8 ~ 10	25	80	31	20	80	58
	11 ~ 13	25	80	31	20	80	58
	14 ~ 16	25	80	42	20	80	58
	17 ~	25	80	42	20	80	58
3 (MXZ-3A)	12 ~	25	80	52	20	80	58
3 (MXZ-4A)	12 ~	25	90	52	20	103	58
4 (MXZ-4A)	16 ~	25	90	52	20	113	58

3-4. HEAT DEFROSTING CONTROL

(1) Starting conditions of defrosting

When the following conditions a) ~ c) are satisfied, the defrosting starts.

a) The defrost thermistor reads 26.6 °F or less.

b) The cumulative operation time of the compressor has reached any of the set values* (31, 35, 45, 55, 65, 75, 85, 95, 105, 115, 150 minutes).

c) More than 5 minutes have passed since the start-up of the compressor.

* Set value of compressor operation time (hereinafter referred to as defrost interval)

This is decided by the temperature of defrost thermistor and ambient temperature thermistor, the previous defrosting time. For example, the first defrost interval is 40 minutes long, and the second is 45 minutes long. The third and subsequent intervals are set to be longer, and less frequent, depending on defrosting time.

The third and subsequent defrost intervals follow any of the three patterns ...5 or 10 to 20 minutes longer, the same, or 5 or 10 to 20 minutes shorter compared with the previous defrost interval ... with the longest 125 minutes and the shortest 40 minutes.

(2) Releasing conditions of defrosting

Defrosting is released when any of the following conditions is satisfied:

a) The defrost thermistor continues to read 50.7 °F.

b) Defrosting time exceeds 10 minutes.

c) Any other mode than HEAT mode is set during defrosting.

3-5. DISCHARGE TEMPERATURE PROTECTION CONTROL

This protection controls the compressor ON/OFF and operation frequency according to temperature of the discharge temperature thermistor.

(1) Compressor ON/OFF

When temperature of the discharge temperature thermistor exceeds 240.8 °F, the control stops the compressor.

When temperature of the discharge temperature thermistor is 176 °F (2A/3A30NA)/ 212 °F (3A30NA-□/4A) or less, the controls starts the compressor.

(2) Compressor operation frequency

When temperature of the discharge temperature thermistor is expected to be higher than 240.8 °F, the control decreases 12 Hz from the current frequency.

When temperature of the discharge temperature thermistor is expected to be higher than 231.8 °F and less than 240.8 °F, the control decreases 6 Hz from the current frequency.

When temperature of the discharge temperature thermistor is expected to be higher than 219.2 °F and less than 231.8 °F, the control is set at the current frequency.

3-6. OUTDOOR FAN CONTROL

Fan speed is switched according to the number of operating indoor unit and the compressor frequency.

<Relation between compressor frequency and fan speed>

Fan speed

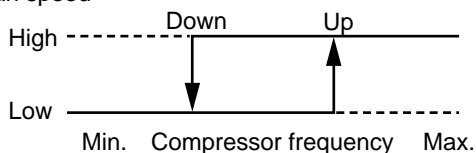

	Compressor frequency (Hz)	
	Down	Up
MXZ-2A MXZ-3A30NA	30	40
MXZ-3A30NA-□ MXZ-4A	40	50

NOTE : When the indoor coil thermistor is 134.6 °F or more on HEAT operation, fan speed is fixed to Low speed.
Or, the indoor coil thermistor is 113 °F or less on HEAT operation, fan speed is back to normal.

3-7. PRE-HEAT CONTROL

MXZ-2A20NA-1 MXZ-3A30NA-1 MXZ-4A36NA

The compressor is energized even while it is not operating.
This is to generate heat at the winding to improve the compressor's start-up condition.

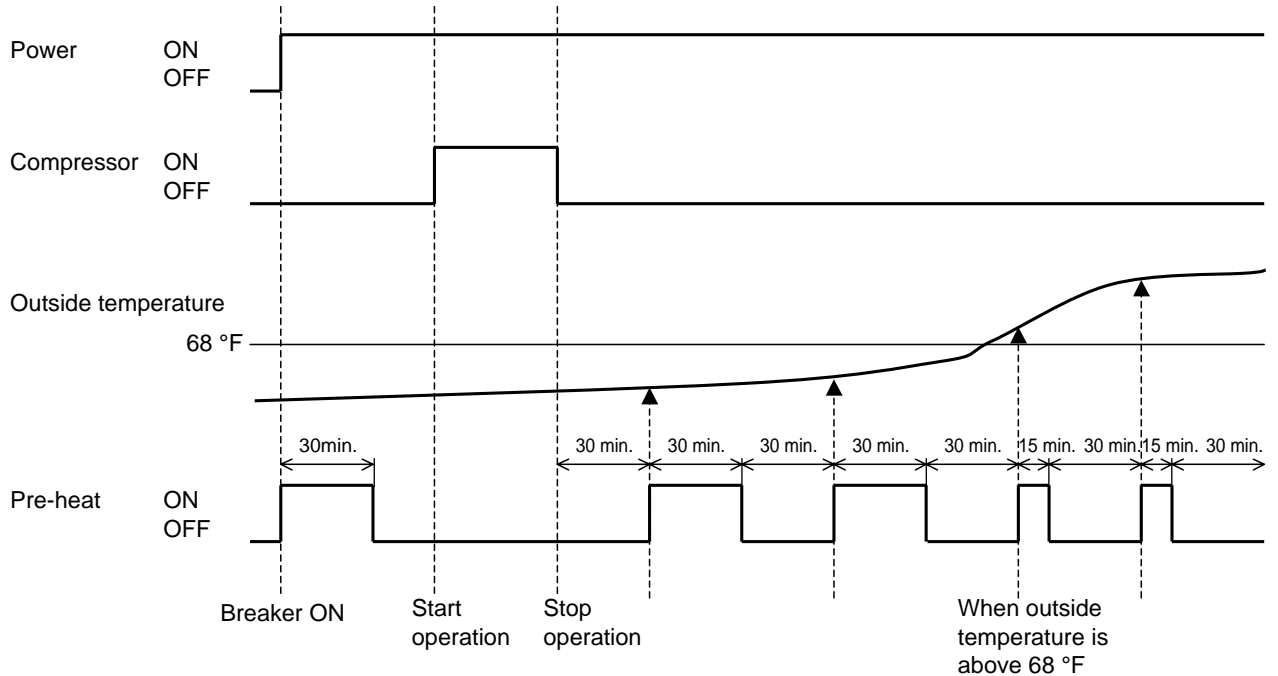

1. Pre-heat control is turned ON for 15 or 30 min,* after the breaker is turned ON.
2. 30 min. after the unit is stopped, pre-heat control is turned ON for 15 or 30 min.* and turned OFF for 30 min." This is repeated as shown in the graph until the breaker is turned OFF.

* When outside temperature is 68 °F or below, pre-heat control is ON for 30 min."
When outside temperature is 69.8 °F or above, pre-heat control is ON for 15 min."

NOTE: When the unit is started with the remote controller, pre-heat control is turned OFF."
Compressor uses 50 W when pre-heat control is turned ON.

3-8. COOL OPERATION

1. Thermostat control

Thermostat is ON or OFF by difference between room temperature and set temperature.

Thermostat	Room temperature minus set temperature (Initial)	Room temperature minus set temperature (During operation)
ON -----	-1.8 °F or more	----- -1.8 °F -1.3 °F
OFF -----	less than -1.8 °F	

2. Coil frost prevention

The compressor operational frequency is controlled to prevent the indoor heat exchanger temperature from falling excessively.

Compressor is turned OFF for 5 minutes when temperature of indoor coil thermistor continues 37.4 °F or less for 5 minutes or more.

3-9. DRY OPERATION

1. Thermostat control

Thermostat is ON or OFF by difference between room temperature and set temperature.

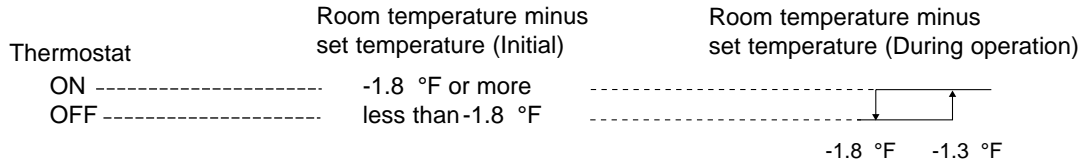

2. Coil frost prevention

Coil frost prevention is as same as COOL mode. (3-8.2.)

3-10. HEAT OPERATION

1. Thermostat control

Thermostat is ON or OFF by difference between room temperature and set temperature.

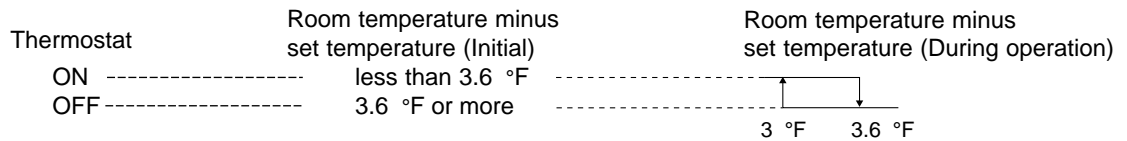

2. High pressure protection

In HEAT operation the indoor coil thermistor detects the temperature of the indoor heat exchanger. The compressor operational frequency is controlled to prevent the condensing pressure from increasing excessively.



HEAD OFFICE: TOKYO BLDG.,2-7-3, MARUNOUCHI, CHIYODA-KU, TOKYO 100-8310, JAPAN

© Copyright 2006 MITSUBISHI ELECTRIC ENGINEERING CO.,LTD
Distributed in Feb. 2008. No. OBT16 REVISED EDITION-B 6
Distributed in May 2007. No. OBT16 REVISED EDITION-A 7
Distributed in Apr. 2006. No. OBT16 7
Made in Japan

New publication, effective Feb. 2008
Specifications subject to change without notice.